



A & A Global Resources PVT LTD Pune

Office Address: Office Number 327, Siddharth Towers 1, S.No.12/3B, Kothrud,
Pune: 411038

190 Lumens/W



**'AGATE' Ultra High
Luminous Efficacy
Street Light**



Product Overview

- Smooth appearance and line design.
- Up to 100,000hrs @ L70, low maintenance cost.
- It can be installed horizontally and vertically, and the adjustable angle is $\pm 15^\circ$.
- The protection grade is IP66 and IK08.
- Tool-less opening of driver box, ease of maintenance.
- ADC12 high-pressure cast aluminum one-piece shell great help for heat dissipation.
- High strength tempered glass lampshade with stronger light transmission performance.
- The hollow design is adopted between the light source and the drive room to improve the air flow rate and heat dissipation capacity.
- Type I / II / III / IV / V light distribution can meet the different requirements of road lighting.
- Strobo-free stable optical output, power factor 0.95 Maintain the stability of the power grid.

Area Application

- Urban and residential area
- Pedestrian category roads
- Vehicle category roads
- Traffic routes and main access road
- Parking areas
- Cycling track
- Footpath



Product Datasheet									
Item No.	AG-UHS-60W	AG-UHS-80W	AG-UHS-100W	AG-UHS-120W	AG-UHS-150W	AG-UHS-200W	AG-UHS-240W	AG-UHS-300W	
Power	60W	80W	100W	120W	150W	200W	240W	300W	
Lumen Efficiency	190lm/w	190lm/w	190lm/w	190lm/w	190lm/w	190lm/w	190lm/w	190lm/w	
Lumen	11400lm	15200lm	19000lm	22800lm	28500lm	38000lm	45600lm	57000lm	
Product Size (mm)	498×180×115	629×250×125	629×250×125	629×250×125	698×280×115	798×280×138	798×280×138	798×280×138	
Electrical Data									
Working Voltage	AC100-265V 50/60Hz								
LED	High Power 5050 EMC Package								
CCT	3000K, 4000K, 5000K, 6000K								
CRI	Ra>70 (Default) / Ra>80								
Driver	Inventronics/MOSO/Meanwell and so on								
THD	<10%								
Power Factor(PF)	PF>0.95								
General Data									
IP Rating	IP66								
IK Rating	IK08								
Holder	50mm/60mm(Default)								
Body Material	High pressure die-cast aluminum								
Housing Color	RAL9007(available on request)								
Cover Material	UV-resistant Polycarbonate								
Working Environment	-20℃~+50℃, 10%~90%RH								
Lifespan L70 at 25℃	>50,000hrs								
Mounting Type	Side entry or Vertical pole mounted ±15°								
Dimmable	1-10V Dimming /Timer Dimming/Dali Dimming								
Protection Class	Class I (Default)/Class II								
Standards	RoHS, LM79, LM80, TM-21, IP66, IK08								
Available on request	Solar Compatible, NEMA socket (3/5/7pins), ZHAGA socket, Short cap, Photocell, Motion sensor, NTC, OLC, DALI Dimming								
Reasonable tolerance	Watt: ±10%, CCT: ±500K, Lumen efficiency: ±5%								

Optional Accessories

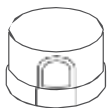

Photocell



Shorting Cap



NEMA Socket
(3 /5 /7pin)

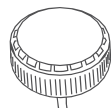

Motion Sensor



Smart Controller



Knife switch

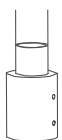

"80-60mm"



"60-40mm"

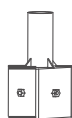

Square to round

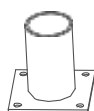

"T" Type

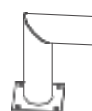

"L" Type

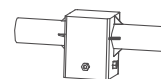

"2" in "1"

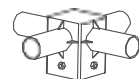

"4" in "1"



3030 Version

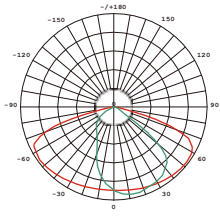

T2S53001

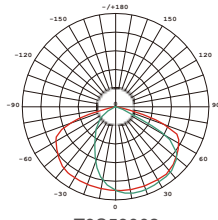

T3S53002

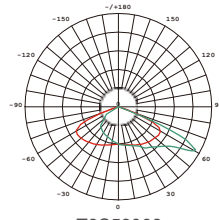

T3S53003

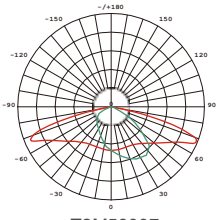

T2M53007

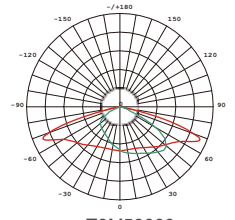

T3M53009

5050 Version

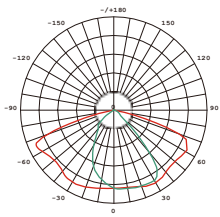

T2S55004

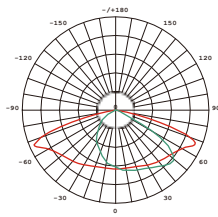

T3M55005

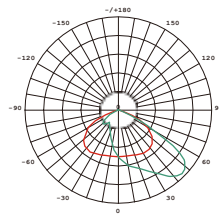

T3S55006

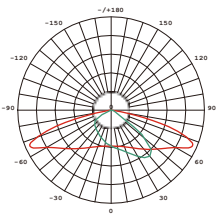

T2M55008

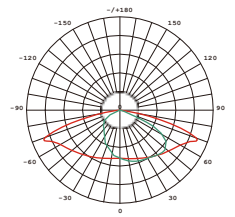

T3M55010

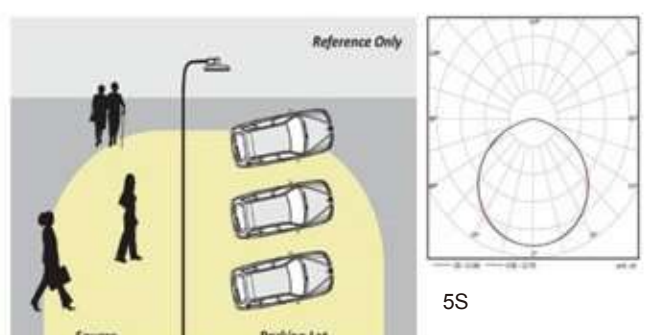
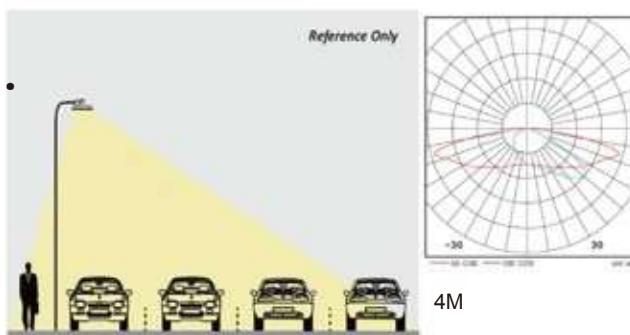
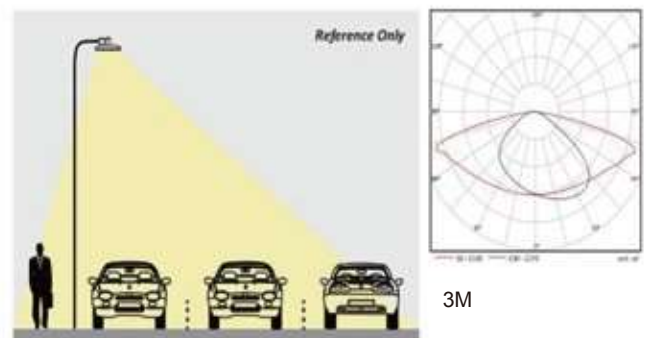
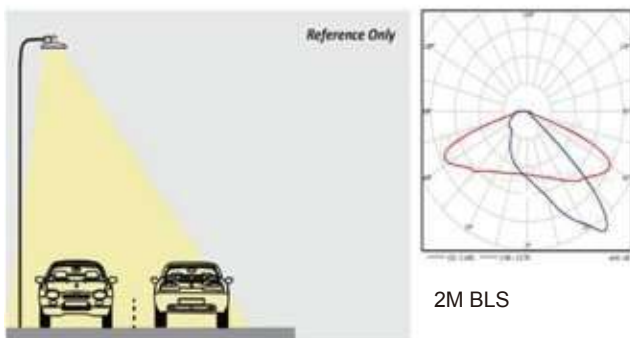
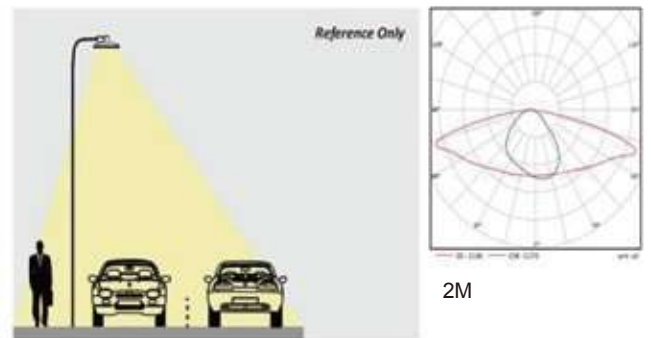
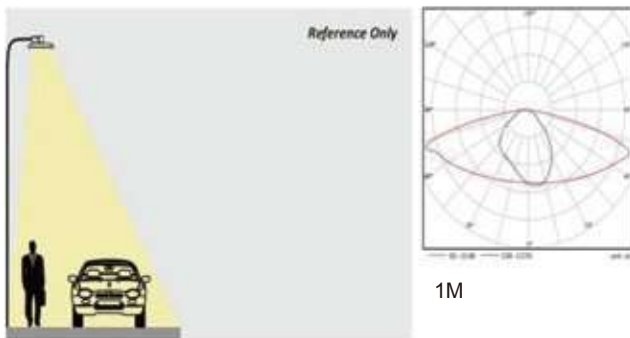

VERSATILE INSTALL : VERSATILE OPTICS

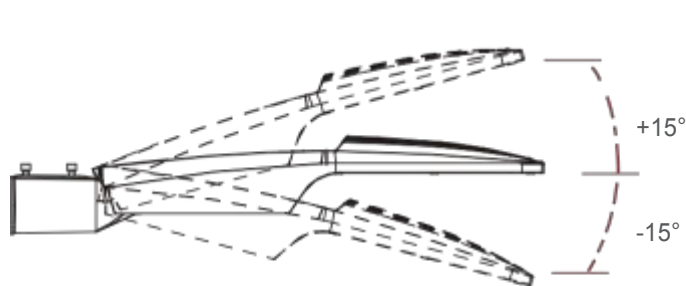

◀ HORIZONTAL INSTALLATION

Tilt of up to $\pm 15^\circ$

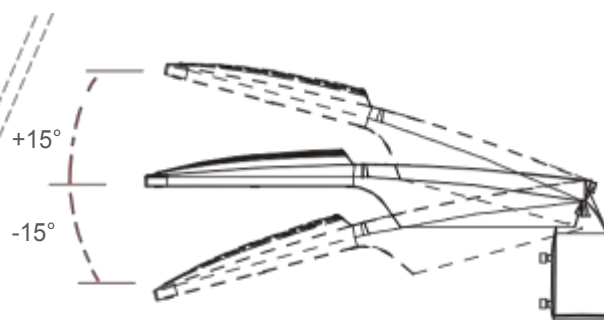

◀ VERTICAL INSTALLATION

Tilt of up to $\pm 15^\circ$

Product Details

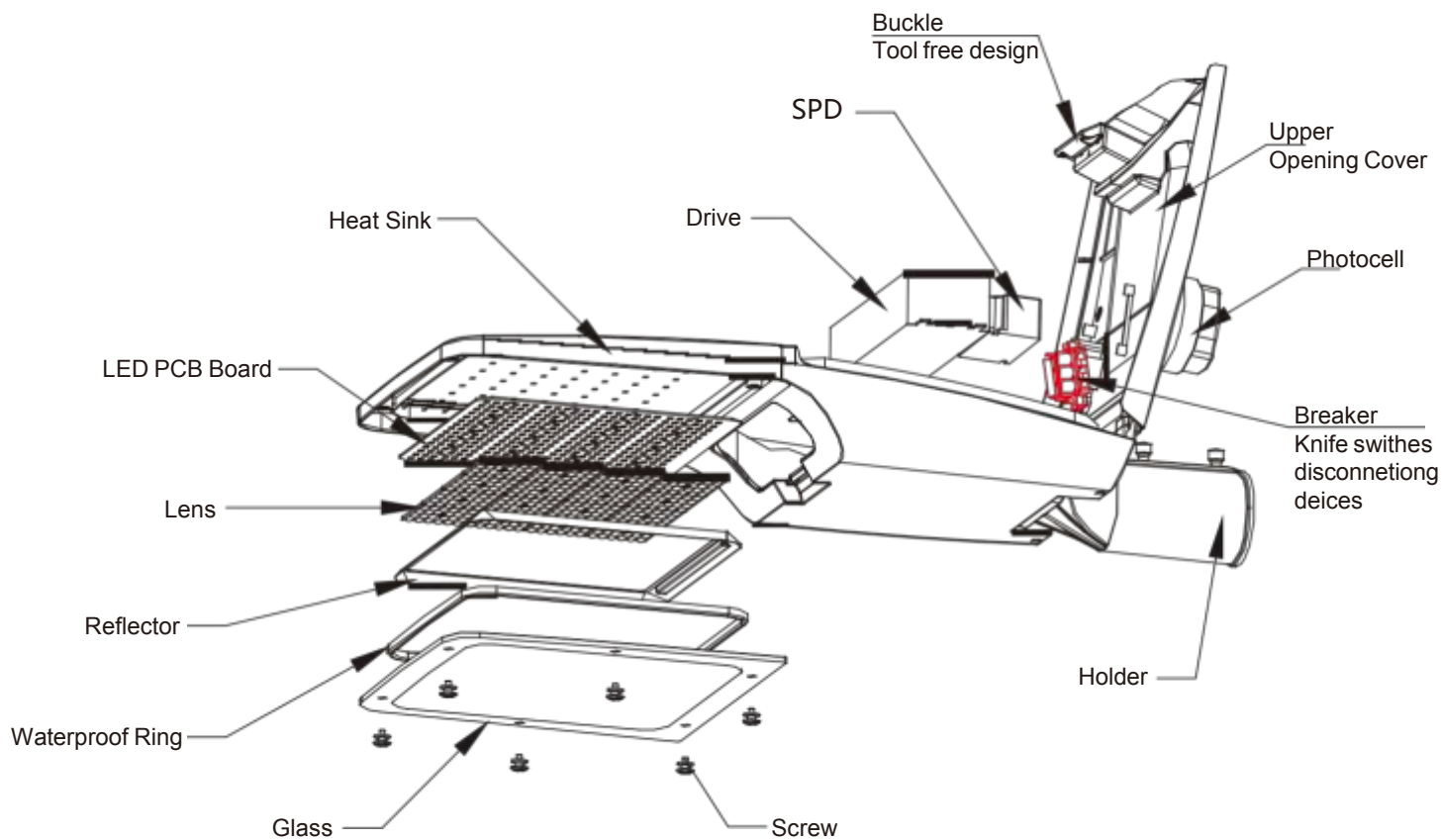

We can provide Simulation service:

- AGI32 Simulation
- Calculux Simulation
- Dialux/EVO Simulation

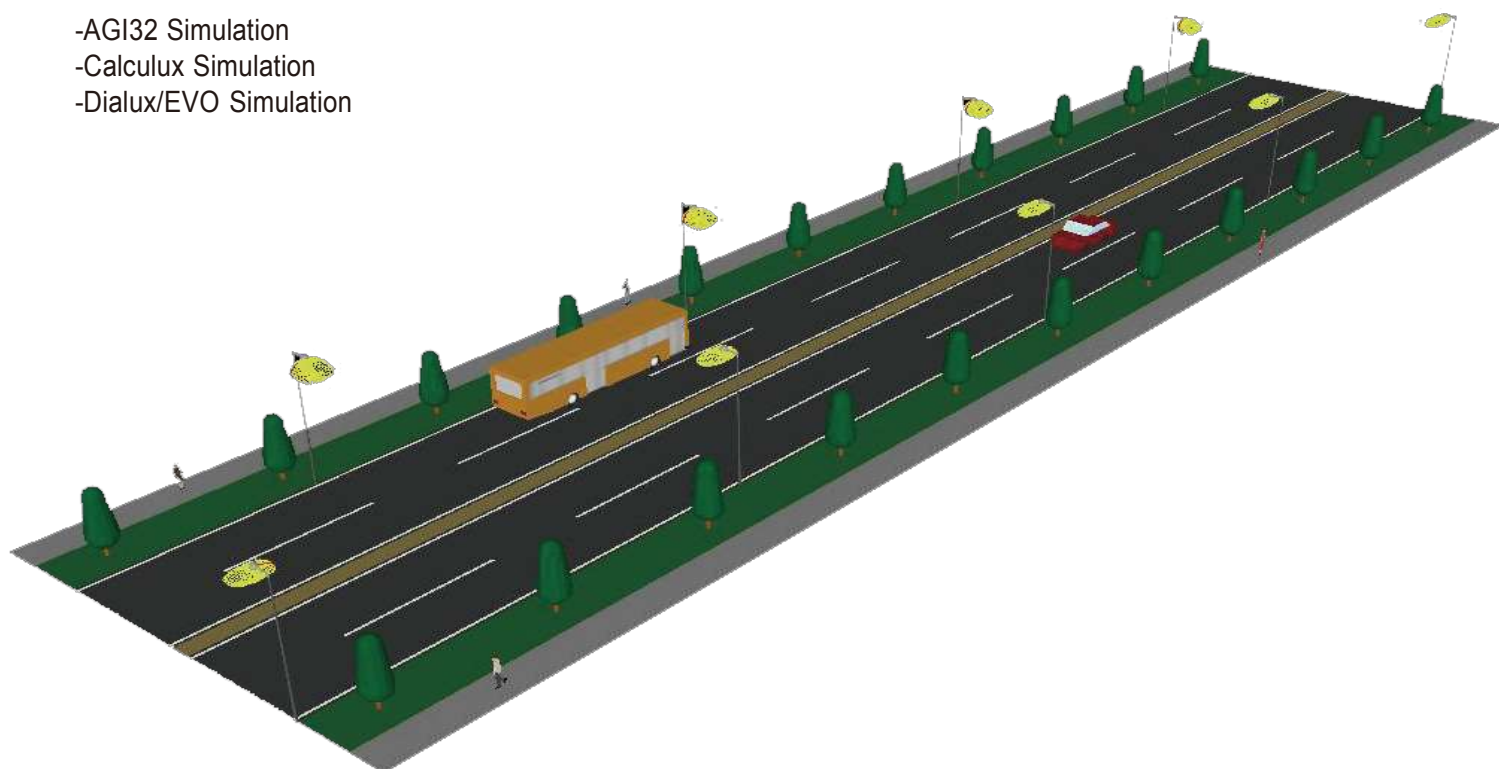

Dimension

Fixture Information		
Version	AxBxC(mm)	kg
SS	498 × 180 × 115	3.2
S	629 × 250 × 125	5.0
M	698 × 280 × 128	6.4
L	798 × 280 × 138	8.4

Package Information				
Version	AxBxC(mm)	G.W(kg)	20GP(Qty)	40HQ(Qty)
SS	525×200×115	3.8	2123pcs	5346pcs
S	655×270×115	5.6	1263pcs	3180pcs
M	725×305×115	7.2	994pcs	2504pcs
L	825×305×115	9	874pcs	2202pcs

